

Dell™ 5100MP Projector

User's Guide

Notes, Notices, and Cautions



NOTE: A NOTE indicates important information that helps you make better use of your projector.



NOTICE: A NOTICE indicates either potential damage to hardware or loss of data and tells you how to avoid the problem.



CAUTION: A CAUTION indicates a potential for property damage, personal injury, or death.

Information in this document is subject to change without notice.

© 2007-2008 Dell Inc. All rights reserved.

Reproduction in any manner whatsoever without the written permission of Dell Inc. is strictly forbidden.

Trademarks used in this text: *Dell* and the *DELL* logo are trademarks of Dell Inc.; *DLP* and *DLP*[®] logo are trademarks of Texas Instruments; *Microsoft* and *Windows* are either registered trademarks or trademarks of Microsoft Corporation in the United States and/or other countries.

Other trademarks and trade names may be used in this document to refer to either the entities claiming the marks and names or their products. Dell Inc. disclaims any proprietary interest in trademarks and trade names other than its own.

May 2008 Rev. A01

Contents

1	Your Dell Projector	6
	About Your Projector	7
2	Connecting Your Projector	8
	Connecting to a Computer	9
	Connecting a Computer with an M1 to D-sub/USB Cable	9
	Connecting a Computer with a D-sub to D-sub Cable	10
	Connecting to a DVD Player	11
	Connecting a DVD Player with an M1 to HDTV Cable	11
	Connecting a DVD Player with a D-sub to YPbPr Cable	11
	Connecting a DVD Player with a RCA to RCA Cable	12
	Connecting a DVD Player with an S-video Cable . .	12
	Connecting a DVD Player with a Composite Cable .	13
	Connecting a DVD Player with a BNC to VGA cable	13
	Professional Installation Options: Installation for Driving Automatic Screen	14
	Installation for wired RS232 remote control: Connection with PC	15
	Connection with Commercial RS232 Control Box: .	16

3	Using Your Projector	17
	Turning Your Projector On	17
	Turning Your Projector Off	17
	Adjusting the Projected Image	18
	Raising the Projector Height	18
	Lowering the Projector Height	18
	Adjusting the Projector Zoom and Focus	19
	Adjusting Projection Image Size	20
	Using the Control Panel	21
	Using the Remote Control	23
	Using the On-Screen Display	26
	Image Settings	26
	Audio Menu	28
	Management Menu	29
	Language Menu	31
	PIP Setting Menu	31
	Network Settings Menu	32
	Factory Reset Menu	33
	Computer Source Menu	33
	Video Source Menu	34
	RF Learning Connections	34
	To Manage the Projector from Web Management	37
4	Troubleshooting Your Projector	43
	Self-diagnostic for Video	46
	Changing the Lamp	46

5	Specifications	48
	 Contacting Dell	54
6	Appendix: Glossary	55

Your Dell Projector

Your projector comes with all the items shown below. Ensure that you have all the items, and contact Dell if anything is missing.

Package Contents

1.8 m power cord (3.0 m in Americas) 1.8 m MI to D-sub/USB cable

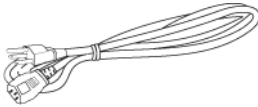

2.0 m S-video cable

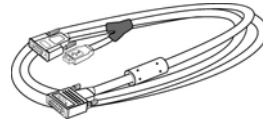

1.8 m Composite Video cable



1.8 m RCA to Audio cable



1.8 m mini pin to mini pin cable



1.8 m MI-A to HDTV cable

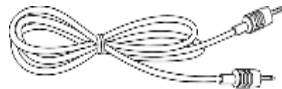

Remote control

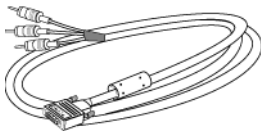

Package Contents *(continued)*

Documentation

Batteries (2)

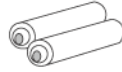

About Your Projector

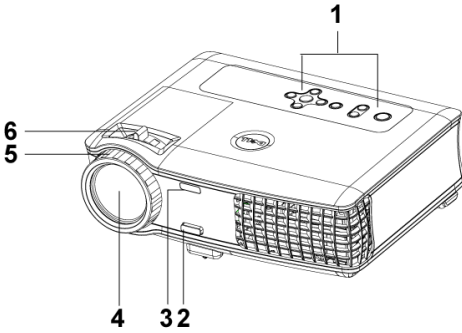

1	Control panel
2	Elevator button
3	Remote control transceiver
4	Lens
5	Lens Cap
6	Focus ring
7	Zoom tab

Connecting Your Projector

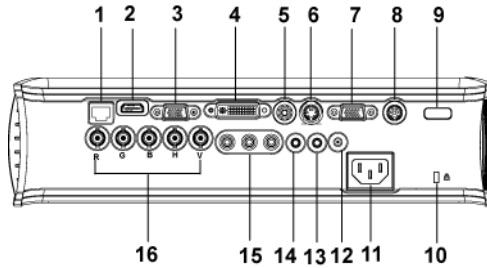

1	RJ45 network connector
2	HDMI connector
3	VGA input connector
4	M1 signal in connector
5	Video input connector
6	S-video input connector
7	VGA output connector
8	RS232 connector
9	IR receiver/ RF transceiver
10	Kensington lock hole
11	Power cord connector
12	12 Volt DC relay output
13	Audio output connector
14	Audio input connector
15	Component video input connector
16	BNC connector

Connecting to a Computer

Connecting a Computer with an M1 to D-sub/USB Cable

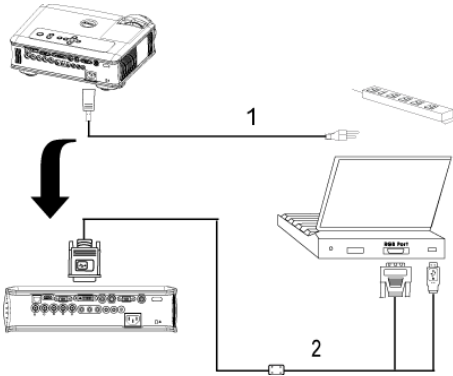

1	Power cord
2	M1A to D-sub/USB cable



NOTE: The USB cable can not be connected if the USB Dongle is used, for the USB dongle connection refer to page 35.

Connecting a Computer with a D-sub to D-sub Cable

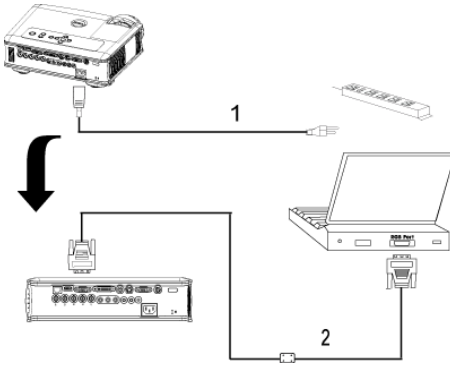

1	Power cord
2	D-sub to D-sub cable



NOTE: The USB cable can not be connected if the USB Dongle is used, for the USB dongle connection refer to page 35.

Connecting to a DVD Player

Connecting a DVD Player with an M1 to HDTV Cable

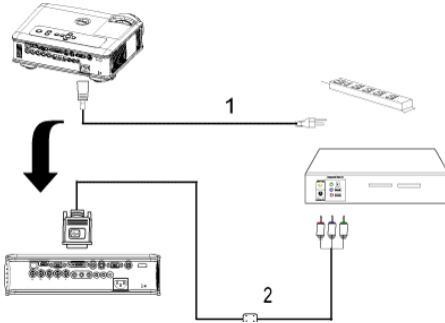

1	Power cord
2	M1 to HDTV cable

Connecting a DVD Player with a D-sub to YPbPr Cable

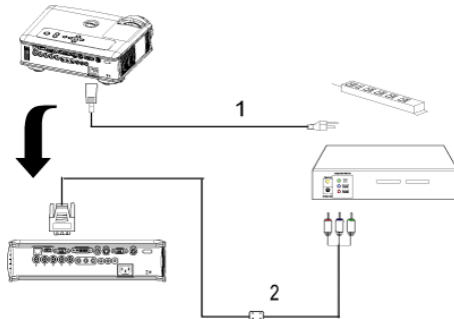

1	Power cord
2	D-sub to YPbPr cable



NOTE: The D-sub to YPbPr cable is not provided by Dell. Consult a professional installer for the cable.

Connecting a DVD Player with a RCA to RCA Cable

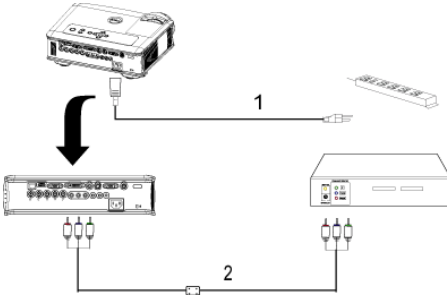

1	Power cord
2	RCA to RCA component cable



NOTE: The RCA to RCA cable is not provided by Dell. Consult a professional installer for the cable.

Connecting a DVD Player with an S-video Cable

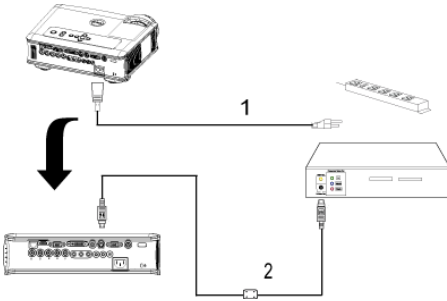

1	Power cord
2	S-video cable

Connecting a DVD Player with a Composite Cable

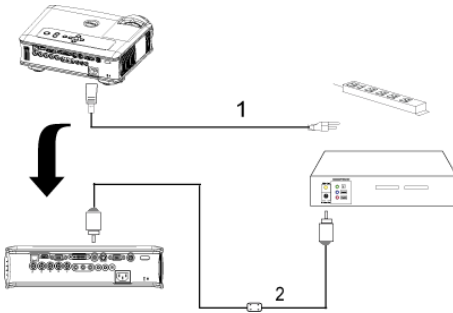

1	Power cord
2	Composite video cable

Connecting a DVD Player with a BNC to VGA cable

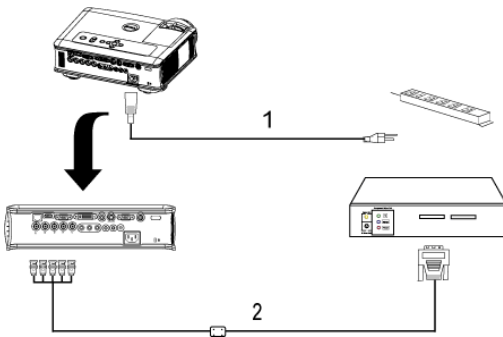

1	Power cord
2	BNC to VGA cable



NOTE: The BNC to VGA cable is not provided by Dell. Consult a professional installer for the cable.

Professional Installation Options: Installation for Driving Automatic Screen

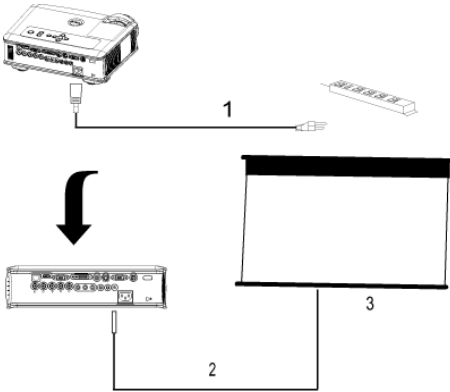

1	Power cord
2	12V DC Plug
3	Automatic screen



NOTE: Use the dimension of 12V DC plug in 1.7mm(ID) x 4.00mm(OD) x 9.5mm (shaft) to connect the automatic screen with the projector.

12V DC Plug



Installation for wired RS232 remote control: Connection with PC

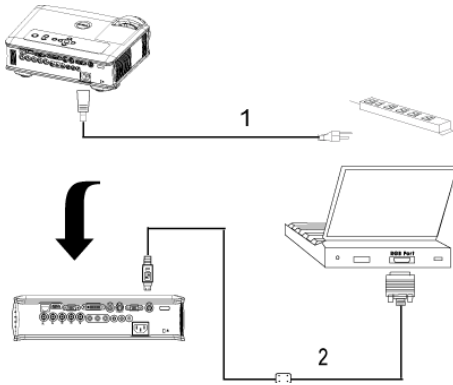

1	Power cord
2	RS232 cable



NOTE: The RS232 cable is not provided by Dell. Consult a professional installer for the cable.

Connection with Commercial RS232 Control Box:

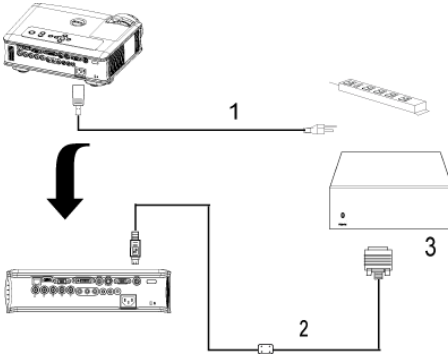

1	Power cord
2	RS232 cable
3	Commercial RS232 control box



NOTE: The RS232 cable is not provided by Dell. Consult a professional installer for the cable.

Using Your Projector

Turning Your Projector On

 **NOTE:** Turn on the projector before you turn on the source. The power button light blinks blue until pressed.

- 1 Remove the lens cap.
- 2 Connect the power cord and appropriate signal cables. For information about connecting the projector, see page 8.
- 3 Press the power button (see page 21 to locate the power button). The Dell logo displays for 30 seconds.
- 4 Turn on your source (computer, DVD player, etc.). The projector automatically detects your source.

If the "Searching for signal..." message appears on the screen, ensure that the appropriate cable(s) are securely connected.

If you have multiple sources connected to the projector, press the **Source** button on the remote control or control panel to select the desired source.

Turning Your Projector Off

 **NOTICE:** Do not unplug the projector before properly shutting down as explained in the following procedure.

- 1 Press the power button.
- 2 Press the power button again. The cooling fans continue to operate for 90 seconds and then go to standby mode.
- 3 To power off the projector quickly, press the Power button while the projectors cooling fans are still running.

 **NOTE:** Before you turn on the projector again, wait for 60 seconds to allow the internal temperature to stabilize.

- 4 Disconnect the power cord from the electrical outlet.

NOTE: If you press the power button while the projector is running, the "Power Off the Lamp?" message appears on the screen. To clear the message, press any button on the control panel or ignore the message; the message disappears after 5 seconds.

Adjusting the Projected Image

Raising the Projector Height

- 1 Press the elevator button.
- 2 Raise the projector to the desired display angle, and then release the button to lock the elevator foot into position.
- 3 Use the tilt adjustment wheel to fine-tune the display angle.

Lowering the Projector Height

- 1 Press the elevator button.
- 2 Lower the projector, and then release the button to lock the elevator foot into position.

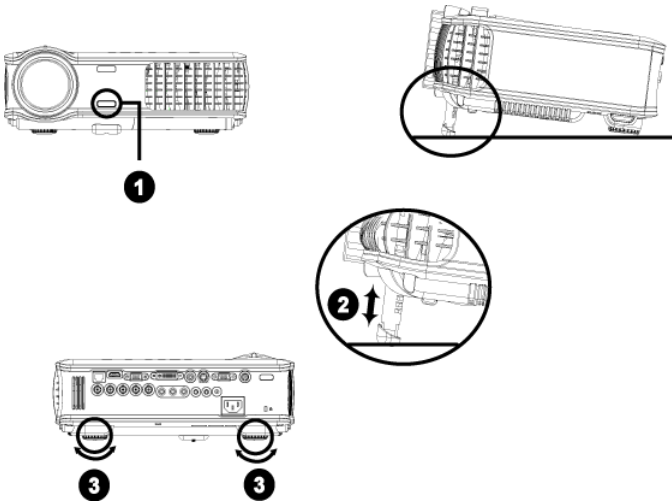

1	Elevator button
2	Elevator foot
3	Tilt adjustment wheel

Adjusting the Projector Zoom and Focus



CAUTION: To avoid damaging the projector, ensure that the zoom lens and elevator foot are fully retracted before moving the projector or placing the projector in its carrying case.

- 1 Rotate the zoom tab to zoom in and out.
- 2 Rotate the focus ring until the image is clear. The projector focuses at distances from 4.9 ft to 39.4 ft (1.5 m to 12 m).

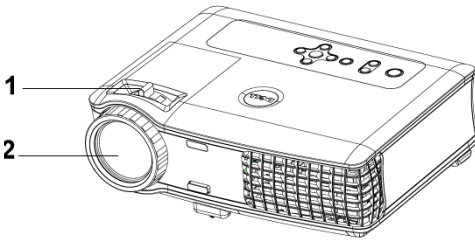

1	Zoom tab
2	Focus ring

Adjusting Projection Image Size

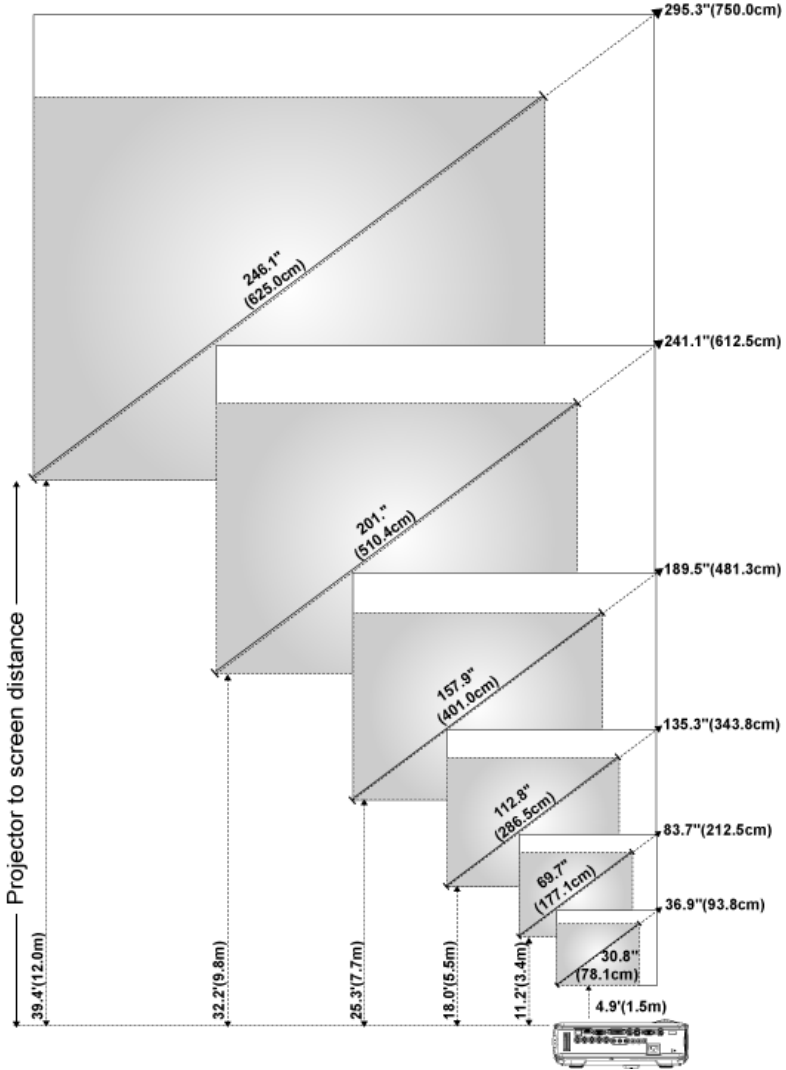

Screen (Diagonal)	Max.	36.9" (93.8cm)	83.7" (212.5cm)	135.3" (343.8cm)	189.5" (481.3cm)	241.1" (612.5cm)	295.3" (750.0cm)
	Min.	30.8" (78.1cm)	69.7" (177.1cm)	112.8" (286.5cm)	157.9" (401.0cm)	201.0" (510.4cm)	246.1" (625.0cm)
Screen Size	Max. (WxH)	29.5" X 22.1"	66.9" X 50.2"	108.3" X 81.2"	151.6" X 113.7"	192.9" X 144.7"	236.2" X 177.2"
		(75.0cm X 56.3cm)	(170.0cm X 127.5cm)	(275.0cm X 206.3cm)	(385.0cm X 288.8cm)	(490.0cm X 367.5cm)	(600.0cm X 450.0cm)
	Min. (WxH)	24.6" X 18.5"	55.8" X 41.8"	90.2" X 67.7"	126.3" X 94.7"	160.8" X 120.6"	196.9" X 147.6"
		(62.5cm X 46.9cm)	(141.7cm X 106.3cm)	(229.2cm X 171.9cm)	(320.8cm X 240.6cm)	(408.3cm X 306.3cm)	(500.0cm X 375.0cm)
Distance		4.9' (1.5m)	11.2' (3.4m)	18.0' (5.5m)	25.3' (7.7m)	32.2' (9.8m)	39.4' (12.0m)
* This graph is for user reference only.							

Using the Control Panel

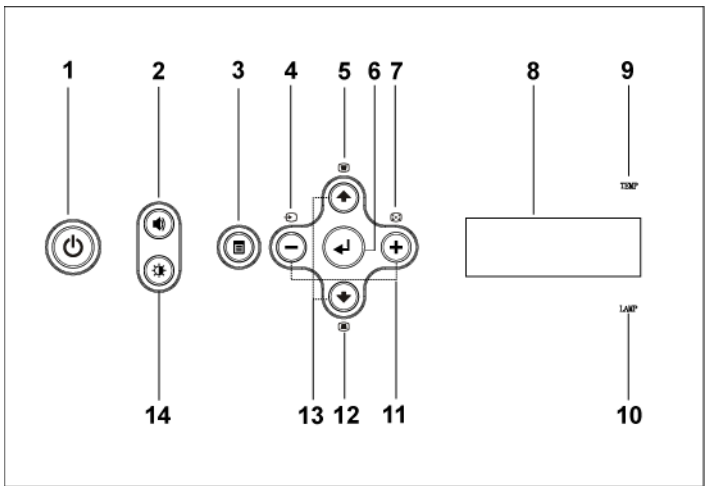

1	Power	Turn the projector on and off. For more information, see page 17.
2	Volume Control	Press to control the volume, then press - or + buttons to decrease or increase the volume.
3	Menu	Press to activate the OSD. Use the directional keys and Menu button to navigate through the OSD.

4	Source	Press to toggle through S-video, Composite Video, M1-D, D-sub, BNC, Component, HDMI and M1 sources when multiple sources are connected to the projector.
5	Keystone adjustment	Press to adjust image distortion caused by tilting the projector. (± 20 degrees)
6	Enter	Press to confirm the selection item.
7	Auto adjust	Press to synchronize the projector to the input source. Auto adjust does not operate if the on-screen display (OSD) is displayed.
8	LCD status display	LCD display is for real time projector status.
9	TEMP warning light	<ul style="list-style-type: none"> • If the TEMP light is solid orange, the projector has overheated. The display automatically shuts down. Turn the display on again after the projector cools down. If the problem persists, contact Dell. • If the TEMP light is blinking orange, a projector fan has failed and the projector automatically shuts down. If the problem persists, contact Dell.
10	LAMP warning light	If the LAMP light is solid orange, replace the lamp.
11	⊖ and ⊕ buttons	Press to adjust the OSD setting.
12	Keystone adjustment	Press to adjust image distortion caused by tilting the projector. (± 20 degrees)
13	Up ⬆ and ⬇ Down	Press to select the OSD items.
14	Brightness and contrast control	Press to control brightness and contrast, press ⬆ or ⬇ to adjust brightness or contrast, then press ⊖ and ⊕ buttons to adjust the value.

Using the Remote Control

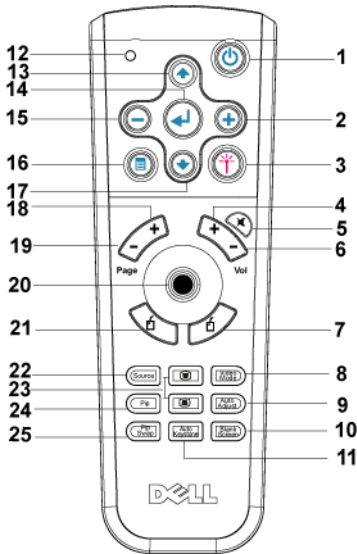

1	Power	Turn the projector on and off. For more information, see page 17.
2	+	Press to adjust the OSD setting.
3	Laser	Aim the remote control at the screen, press and hold the laser button to activate the laser light.
4	Volume +	Press to increase the volume.
5	Mute	Press to mute or un-mute the projector speaker.
6	Volume -	Press to decrease the volume.
7	Right click	Mouse right click.

8	Video mode	The Dell 5100MP Micro-projector has preset configurations that are optimized for displaying data (PC Graphics) or video (movies, games, etc.). Press Video Mode button to toggle between PC mode , Movie mode , Game Mode , sRGB , or User mode (for user to setup and save preferred settings). Pressing the Video Mode button once will show the current display mode. Pressing the Video Mode button again will switch between modes.
9	Auto Adjust	Press to synchronize the projector to the input source. Auto Adjust does not operate if the OSD (On-Screen Display) is displayed.
10	Blank screen	Press to hide the image, press again to resume display of the image.
11	Auto keystone	Press to enable the auto correction for image distortion due to tilting the projector.
12	LED light	LED indicator.
13	Up button	Press to select OSD items.
14	Enter button	Press to confirm the selection.
15	⊖	Press to adjust the OSD setting.
16	Menu	Press to activate the OSD.
17	Down button	Press to select OSD items.
18	Page ◀	Press to move to previous page.
19	Page ▶	Press to move to next page.
20	PC/Mouse control	The PC/Mouse control can be used to control mouse movement. The mouse function is enabled using the M1 cable to connect your computer and the projector.
21	Left click	Mouse left click.
22	Source	Press to switch between Analog RGB, Digital RGB, Composite, Component-i, S-video, and Analog YPbPr sources.
23	Keystone correction	Press to correct the image distortion.
24	PIP	Press the PIP button to turn on/off the PIP screen.

25 PIP Swap

Press the PIP Swap button to swap between the foreground and background.

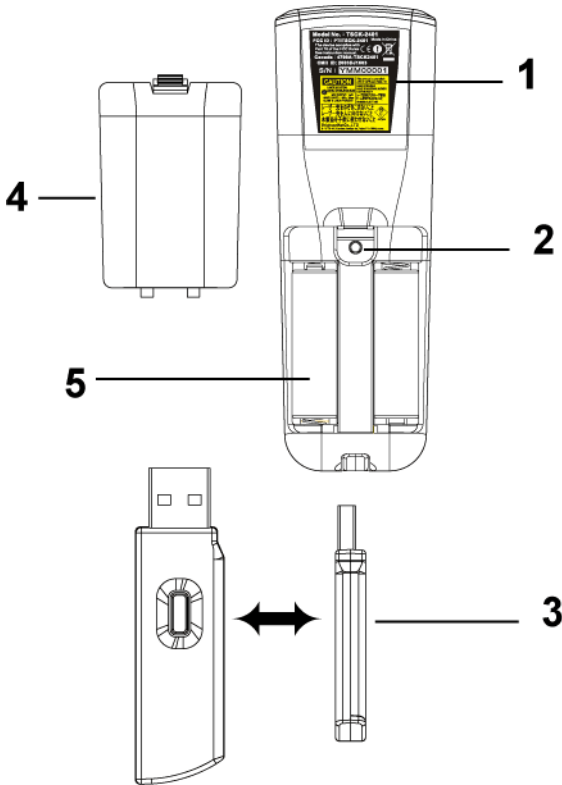

1 Laser Warning

The remote control is equipped with a Class II laser that emits laser radiation. To reduce the risk of injury, do not look directly into the laser light, and do not point the laser light into anyone's eyes.



2 Program button





Initiate the **Learning Mode** on the remote for switching the RF transmission channel by pressing **Prgm** button.

3	Wireless USB mouse dongle	The wireless USB device for controlling PC or Notebook mouse through the remote control.
4	Remote cover	The back cover of the remote control.
5	Battery chamber	The chamber of the battery.

Using the On-Screen Display

The projector has a multi-language On-Screen Display (OSD) that can be displayed with or without an input source present.

In the Main Menu, press  or  to navigate through the tabs. Press Enter button on the control panel or the remote control to select a submenu.

In the submenu, press  or  to make a selection. When an item is selected, the color changes to dark blue. Use  or  on the control panel or the remote control to make adjustments to a setting.

To back to the previous OSD, go to Back tab and press **Enter** button on the control panel or the remote control.

To exit the OSD, go to Exit tab and press Enter button on the control panel or the remote control.

Image Settings



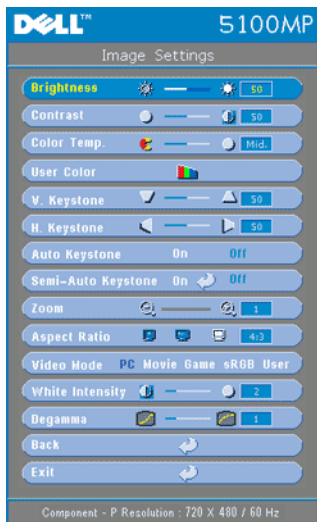

BRIGHTNESS—Use \ominus and \oplus to adjust the brightness of the image.

CONTRAST—Use \ominus and \oplus to control the degree of difference between the brightest and darkest parts of the picture. Adjusting the contrast changes the amount of black and white in the image.

COLOR TEMP.—Adjust the color temperature. The higher the temperature, the screen appears more blue; the lower the temperature, the screen appears more red. User mode activates the values in the "color setting" menu.

USER COLOR—This mode allows manual adjustment of red, green, and blue color settings. Modifying these values will automatically change the color temperature

to "user". Press the **User Color**, then go into the **Color Setting Menu**.

V. KEYSTONE—Adjust image distortion caused by tilting the projector.

H. KEYSTONE—Adjust image distortion caused by horizontal shifting of the projector orientation.

AUTO KEYSTONE—Select **On** to enable the auto correction for vertical image distortion due to tilting the projector. Select **Off** to disable the auto correction.

SEMI-AUTO KEYSTONE—Select **On** and press **Enter** to activate the Semi-Auto keystone correction for image distortion. A specific image pattern will be present on the screen once it's been activated and then complete the settings by following below instructions.

- Adjust the projected image display to appropriate location on the screen.
- Use up, down, left or right button to choose one corner and press **Enter** key to enter keystone correction mode.
- Use up, down, left or right button to move the angle and press **Enter** to confirm.

Zoom—Press \oplus to \ominus digitally magnify an image to 10 times on the projection screen and press \ominus to reduce the zoomed image.

ASPECT RATIO—Select an aspect ratio to adjust how the image appears.

- **1:1** — The input source displays without scaling.

Use 1:1 aspect ratio if you are using one of the following:

- VGA cable and the computer has a resolution less than SXGA+ (1400 x 1050)

- Component cable (720p, 576i/p, 480i/p)
- S-Video cable
- Composite cable
- **16:9** — The input source scales to fit the width of the screen.
- **4:3** — The input source scales to fit the screen.
Use 16:9 or 4:3 if you are using one of the following:
 - Computer resolution greater than SXGA+
 - Component cable (1080i/p)

VIDEO MODE—Select a mode to optimize the display image based on how the projector is being used: **Movie**, **Game**, **PC**, **sRGB** (provides more accurate color representation), and **User** (set your preferred settings). If you adjust the settings for **White Intensity** or **Degamma**, the projector automatically switches to **User**.

WHITE INTENSITY—Setting 0 to maximize the color reproduction and 10 to maximize the brightness.

DEGAMMA—Adjust between 1 and 4 to change the color performance of the display. The default setting is 3.

Audio Menu



VOLUME—Press \ominus to decrease the volume and \oplus to increase the volume.

TREBLE—Control the higher frequencies of your audio source. Press \ominus to decrease the treble and press \oplus to increase the treble.

BASS—Control the lower frequencies of your audio source. Press \ominus to decrease the bass and press \oplus to increase the bass.

MUTE—Allow to mute the volume.

AUDIO SOURCE—Select **HDMI** to have the HDMI output source, and select **Audio** to have the audio output source.

Management Menu

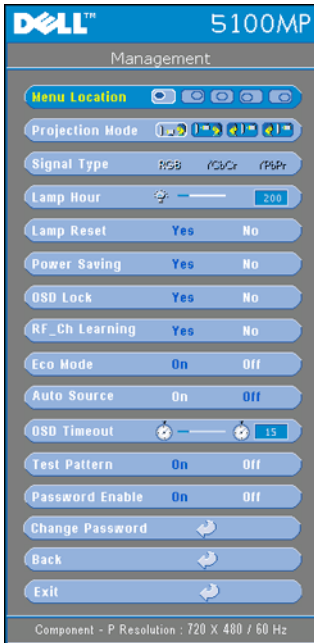

MENU LOCATION—Select the location of the OSD on the screen.

PROJECTION MODE—Select how the image appears:

- Front Projection-Desktop (the default).
- Rear Projection-Desktop-- The projector reverses the image so you can project from behind a translucent screen.
- Front Projection-Ceiling Mount-- The projector turns the image upside down for ceiling-mounted projection.
- Rear Projection-Ceiling Mount-- The projector reverses and turns the image upside down. You can project from behind a translucent screen with a ceiling-mounted projection.

SIGNAL TYPE—Show signal type RGB, YCbCr, YPbPr.

LAMP HOUR—Display the operating hours since the lamp timer reset.

LAMP RESET—After you install a new lamp,

select **Yes** to reset the lamp timer.

POWER SAVING—Select **Yes** to set the power saving delay period. The delay period is the amount of time you want the projector to wait without signal input. After that set time, the projector enters power saving mode and turns off the lamp. The projector turns back on when it detects an input signal or you press the power button. After two hours, the projector turns off and you need to press the power button to turn the projector on.

OSD LOCK—Select **Yes** to enable **OSD Lock** for hiding the OSD menu. (Or pressing the Menu button on control for 15 seconds), and select **No** to disable the **OSD Lock** for hiding the OSD menu. (Or pressing the Menu button on control for 15 seconds again).

RF_CH LEARNING—Refer to page 34.

ECO MODE—Select **On** to use the projector at a lower power level (250 Watts), which may provide longer lamp life, quieter operating and dimmer luminance output on the screen. Select **Off** to operate at normal power level (300 Watts).

AUTO SOURCE—Select **On** (the default) to autodetect the available input signals. When the projector is on and you press **SOURCE**, it automatically finds the next available input signal. Select **Off** to lock the current input signal. When **Off** is selected and you press **SOURCE**, you select which input signal you want to use.

OSD TIMEOUT—Adjust the time delay of the OSD **Timeout**. The Default setting is 30 seconds.

TEST PATTERN—Select **On** to come up the built-in **Test Pattern** for self-testing on focus and resolution.

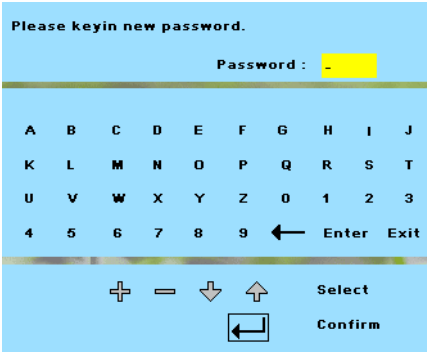



PASSWORD ENABLE—Select **On** to set one password for individual. Select **Off** to disable the password function.

CHANGE PASSWORD—Press to change the password to your preference.

Language Menu



Press  or  to select the preferred language for the OSD.

PIP Setting Menu

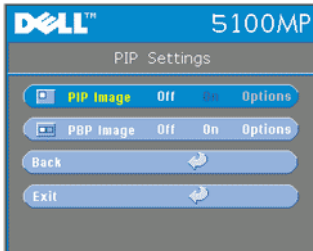

 **NOTE 1:** PIP Image is enabled only when both the following types of signals are connected to the projector.

Type 1: S-Video, Composite Video, MI-D, and

Type 2: D-sub, BNC, Component, HDMI, MI signals.

 **NOTE 2:** When swapping the foreground and background displays, the smallest screen size of foreground display will vary depending on different combinations of signal sources for PIP.

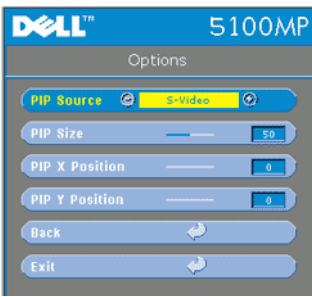

PIP IMAGE—Select **On** to enter **Options** to select following settings. Select **Off** to disable the picture-in-picture display function.

PIP SOURCE—Use **PIP Source** to step through the display source one by one for the foreground display. The possible PIP source is available in the OSD selection depending on the current primary input source. The possible combination of the sources refer to page 51.

PIP SIZE—Adjust the image size of the foreground display.

PIP X POSITION—Horizontally adjust the image position of the PIP display.

PIP Y POSITION—Vertically adjust the image position of the PIP display.

PBP IMAGE—Select **On** to enable the picture-by-picture display. Select **Off** to disable the picture-by-picture function.

Network Settings Menu



DHCP—Select **On** to assign an IP address to the projector from a **DHCP** server automatically. Select **Off** to assign an IP address manually.

IP ADDRESS—Press **Enter** to set up an IP address. Press left or right button to select the number position, up or down button to change the number.

SUBNET MASK—Press **Enter** to set up a subnet mask number. Press left or right button to select the number position, up or down button to change the number.

GATEWAY—Select to set the default gateway of the network connected to the projector. Press left or right button to select the number

position, up or down button to change the number.

DNS—Type in the IP address of DNS server on the network connected to the projector. 12 numeric characters are used.

APPLY CHANGE—Press to confirm the settings.

RESET NETWORK SETTING—Press to the default setting.

Factory Reset Menu

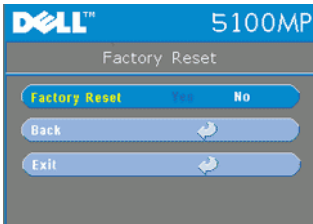

FACTORY RESET—Select **Yes** to reset the projector to its factory default settings. Reset items include both computer image and video image settings

Computer Source Menu

 **NOTE:** This menu is only available connected to a computer.

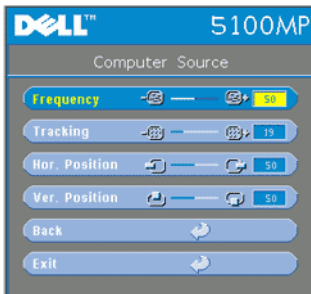

FREQUENCY—Change the display data clock frequency to match the frequency of your computer graphics card. If you see a vertical flickering bar, use **Frequency** control to minimize the bars. This is a coarse adjustment.

TRACKING—Synchronize the phase of the display signal with the graphic card. If you experience an unstable or flickering image, use the **Tracking** to correct it. This is a fine adjustment.

 **NOTE:** Adjust the **Frequency** first and then the **Tracking**.

HOR. POSITION—Press \ominus to adjust the horizontal position of the image to the left and \oplus to adjust the horizontal position of the image to the right.

VER. POSITION—Press \ominus to adjust the vertical position of the image down and \oplus to adjust the vertical position of the image up.

Video Source Menu



NOTE: This menu is only available with S-video, Video (composite) signal connected.



SATURATION—Adjust a video source from black and white to fully saturated color. Press \ominus to decrease the amount of color in the image and \oplus to increase the amount of color in the image.

SHARPNESS—Press \ominus to decrease the sharpness and \oplus to increase the sharpness.

TINT—Press \ominus to increase the amount of green in the image and \oplus to increase the amount of red in the image.

RF Learning Connections

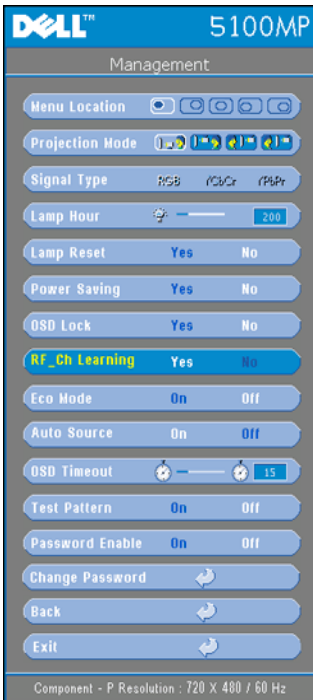

Auto Learning to Change RF Channel Between Remote Controller and Projector

- Power on the projector.
- Press the "Menu" button on control panel, then enter to "Management-->RF_Ch Learning" menu.
- Select **Yes** with the control buttons to enter the **Learning Standby** mode. The projector will switch to standby mode for **RF Learning** and display the **RF Learning** menu.
- Open the battery cover on the remote control and press the **Prgm** button to initiate the **RF Learning** process for the remote control and projector.

Back to Factory Default for the RF Channel

- Select **Yes** on **RF Learning Setting** menu and then enter the **RF Reset to Default** menu. Select **Reset to Default Channel**, the projector will back to the factory default channel.

- Press the **Prgm** button on the remote control for 5 seconds to reset the transmitter to the factory default channel.
- The successful reset back to the default channel on both ends can be confirmed when the remote control transmitter controls the projector.

Auto Learning to Change RF Channel Between Remote Controller and USB Wireless Dongle

Step 1	Open the cover of the remote control.
Step 2	Push the dongle.
Step 3	Take out the dongle from the remote control.
Step 4	Plug the dongle in the USB port on your desktop or notebook computer, the dongle will show red .
Step 5	Press the LED button on the dongle and it will flash "red" for 13 seconds.
Step 6	<p>Press the Prgm button in the rear of the remote control, within 13 seconds to initiate the RF Learning process.</p> <ul style="list-style-type: none"> • If the processes are successful, the dongle LED will remain "red" and stop flashing. • Checking the mouse function are enable by using the remote control, if it has done, the dongle LED will show a "green" signal.
Step 7	Using the remote control to manage your desktop or notebook computer.

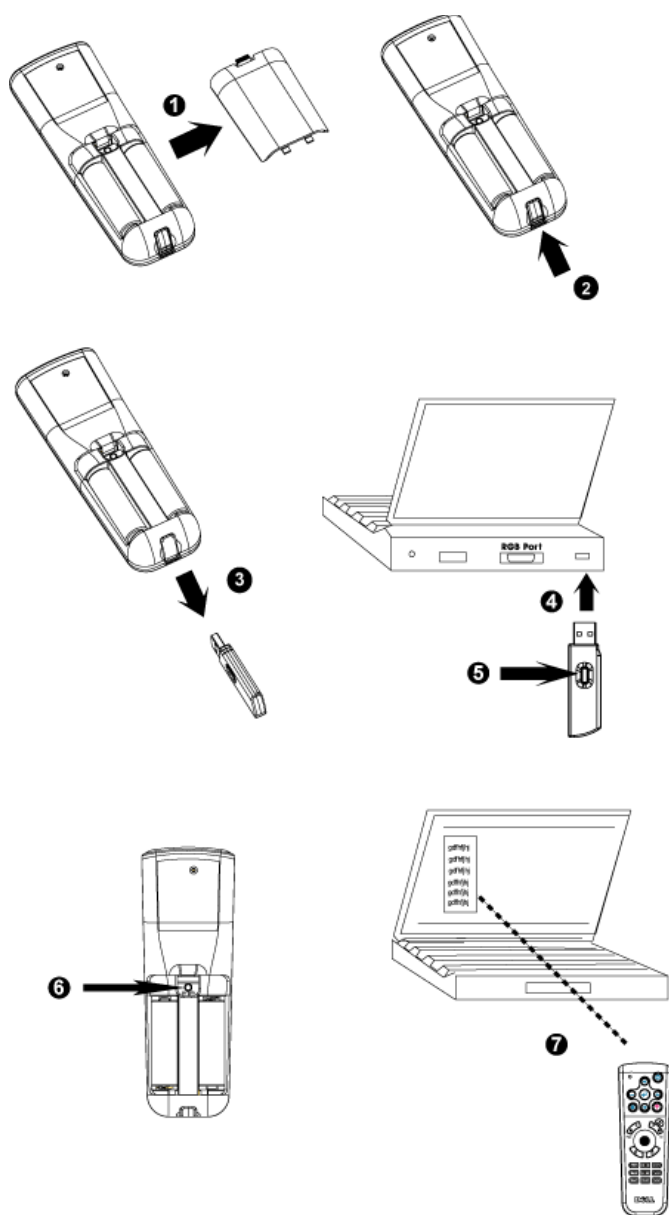

To Manage the Projector from Web Management

Configuring the Network Setting

If the projector is connected to a network, you can access the projector using a web browser by configuring the network setting (TCP/IP). When using the network function, the IP address should be unique. For configuring the network setting, refer to Network Setting Menu in page 32.

Accessing Web Management

Use Internet Explorer 5.0 and above or Netscape Navigator 7.0 and above and enter the IP address. You can now access **Web Management** and manage the projector from a remote location.

Managing Properties

Home

The screenshot shows the DELL 5100MP Web Management interface. On the left is a navigation menu with links to Home, Network Setting, Projector Status and Control, E-mail Alert, and Password Setting. The main content area is titled 'Home' and displays a welcome message and projector information. The projector information includes Group Name (5100MP), Projector Name (D12020), Location, Contact, Status (Standby), Lamp Hours (0 hr), Firmware Version (A0.60), IP Address (192.168.4.50), MAC Address (00:60:E9:01:2E:F4), and Admin Password (Disable). At the bottom, there is a language selection dropdown set to 'English' and a 'Submit' button.

Displays Group name, Projector name, Location, Contact, Lamp hours, Firmware version, IP address, MAC address and Admin password information.

Network Setting

See OSD section on page 32.

DELL™ 5100MP Web Management

Network Settings

Group Name:

Projector Name:

Location:

Contact:

DHCP Manual

IP Address:

Subnet Mask:

Gateway:

DNS Server:

- Set up the Group Name, Projector Name, Location and Contact information in this tab, press **Submit** to confirm the settings.
- Choose **DHCP** to assign an IP address to the projector from a **DHCP** server automatically, or **Manual** to assign an IP address manually.

Projector Status and Control

The function is same as On Screen Display.

DELL™ 5100MP Web Management

- [▶ Home](#)
- [▶ Network Setting](#)
- [▶ Projector Status and Control](#)
- [▶ E-mail Alert](#)
- [▶ Password Setting](#)

Projector Status and Control

Projector Status

Projector Status

Power Saving

Lamp Hours

Error Status

Image Control

Operation Mode Full Power ECO Mode

Projection Mode

Source Select

Video Mode

Blank screen On Off

Aspect Ratio 1:1 16:9 4:3

Brightness (0~100)

Contrast (0~100)

Audio Control

Volume (0~30)

Manage the projector status, image control and audio control using Projector Status and Control.

E-mail Alert

The screenshot shows the Dell 5100MP Web Management interface. The top navigation bar is blue with the Dell logo and the text "5100MP Web Management". On the left, a grey sidebar contains a menu with five items: "Home", "Network Setting", "Projector Status and Control", "E-mail Alert" (which is highlighted with a blue border), and "Password Setting". The main content area is titled "E-mail Alert" in blue. It features a section for "E-mail Alert" with radio buttons for "Enable" and "Disable" (the "Disable" option is selected). Below this are four text input fields for "TO", "CC", "From", and "Subject". The "Subject" field contains the text "5100MP-D12020 Alert". Underneath is the "SMTP Setting" section with three text input fields for "Out going SMTP server", "User name", and "Password". The "Alert Condition" section has three checkboxes: "Lamp warning", "Low lamp life", and "Temperature warning", all of which are currently unchecked. At the bottom of the form are two buttons: "E-mail Alert Test" and "Submit".

Set E-mail address, Owner, Subject and **Alert Condition** to send automatic e-mail alerts to the preset administrator.

Password Setting

DELL™ 5100MP Web Management

▶ [Home](#)

▶ [Network Setting](#)

▶ [Projector Status and Control](#)

▶ [E-mail Alert](#)

▶ [Password Setting](#)

Password Setting

To enable password function during first-time use, set password before you enable it. When password function is enabled, an Administrator Password will be required when you connect to the web management.

Administrator

Password Enable Disable



New Password





Confirm Password

Use Password Setting to set up an administrator password to access the **Web Management**. When enabling password for the first time, set the password before enabling it. When the password function is enabled, the administrator password will be required for accessing the **Web Management**.

Troubleshooting Your Projector

If you experience problems with your projector, see the following troubleshooting tips. If the problem persists, contact Dell.

Problem	Possible Solution
No image appears on the screen	<ul style="list-style-type: none">• Ensure that the lens cap is removed and the projector turned on.• Ensure the external graphics port is enabled. If you are using a Dell portable computer, press  . For other computers, see your documentation.• Ensure that all the cables are securely connected. See "Connecting Your Projector" on page 8."• Ensure that the pins of the connectors are not bent or broken.• Ensure that the lamp is securely installed (see "Changing the Lamp" on page 46").• Run Self-diagnostic test. See "Self-diagnostic for Video" on page 46. Ensure that the colors of the test pattern are correct.

Problem (continued)	Possible Solution (continued)
Partial, scrolling, or incorrectly displayed image	<ul style="list-style-type: none"> • Press the Resync button on the remote control or the control panel. • If you are using a Dell portable computer, set the resolution of the computer to XGA (1024 x 768): <ol style="list-style-type: none"> a Right-click the unused portion of your Windows desktop, click Properties and then select Settings tab. b Verify the setting is 1024 x 768 pixels for the external monitor port. c Press  . <p>If you experience difficulty in changing resolutions or your monitor freezes, restart all the equipment and the projector.</p> <p>If you are not using a Dell portable computer, see your documentation.</p>
The screen does not display your presentation	If you are using a portable computer, press   .
Image is unstable or flickering	Adjust the tracking in the OSD Computer Source tab.
Image has vertical flickering bar	Adjust the frequency in the OSD Computer Source tab.
Image color is not correct	<ul style="list-style-type: none"> • If your graphic card output signal is sync on Green, and you would like to display VGA at 60Hz signal, please go into OSD select Management, select Signal Type and then select RGB. • Run the Self-diagnostic test (see " Self-diagnostic for video ") for preliminary diagnostic on image color problem. Ensure that the colors of the test pattern are correct.
Image is out of focus	<ol style="list-style-type: none"> 1 Adjust the focus ring on the projector lens. 2 Ensure that the projection screen is within the required distance from the projector (4.9 ft [1.5 m] to 39.4 ft [12 m]).

Problem (continued)	Possible Solution (continued)
The image is stretched when displaying a 16:9 DVD	<p>The projector automatically detects a 16:9 DVD and adjusts the aspect ratio to full screen with a 4:3 (letter-box) default setting.</p> <p>If the image is still stretched, adjust the aspect ratio as follows:</p> <ul style="list-style-type: none"> • If you are playing a 16:9 DVD, select 4:3 aspect ratio type on your DVD player (if capable). • If you cannot select 4:3 aspect ratio type on your DVD player, select 4:3 aspect ratio in the Image Settings menu in the OSD.
Image is reversed	Select Management from the OSD and adjust the projection mode.
Lamp is burned out or makes a popping sound	When the lamp reaches its end of life, it may burn out and may make a loud popping sound. If this occurs, the projector does not turn back on, and displays Lamp Defective in the LCD display until the lamp is replaced. To replace the lamp, see "Changing the Lamp" on page 46.
LAMP light is solid orange	If LAMP light is solid orange, replace the lamp.
Interlock failed	If the LAMP light is blinking orange, the lamp cover is not closed properly. Close the lamp cover properly. If the problem persists, contact Dell.
TEMP light is solid orange	The projector has overheated. The display automatically shuts down. Turn the display on again after the projector cools down. If the problem persists, contact Dell.
TEMP light is blinking orange	A projector fan has failed and the projector will automatically shut down. If the problem persists, contact Dell.
The remote control is not operating smoothly or in very limited range	The battery may be low. Check if the laser beam transmitted from the remote is too dim. If so, replace with 2 new AA batteries.

Self-diagnostic for Video

Dell 5100MP Projector provides self-diagnostic test of the projector video display (for Video, S-video, Component-i). Use this advanced feature for preliminary self-diagnostic on your projector when encountering a display problem for video.

- 1 After turning on the projector, press "+" and "-" buttons on the control panel simultaneously for 3 seconds and release the buttons when screen goes blank.
- 2 Press "+" and "-" buttons again to exit the diagnostic mode.
- 3 While in Self-diagnostic mode, the screen will run a seven-color-cycle test as following:
Red--> Green--> Blue--> White--> Watchet Blue--> Dark Green--> Yellow.
Ensure that the colors of the test pattern are correct. Contact Dell if the colors are not displayed correctly.

Changing the Lamp

Replace the lamp when you see "Lamp is approaching the end of its useful life in full power operation. Replacement suggested! www.dell.com/lamps" appears on the screen. If this problem persists after replacing the lamp, contact Dell.



CAUTION: The lamp becomes very hot when in use. Do not attempt to replace the lamp until the projector has been allowed to cool down for at least 30 minutes.





CAUTION: Do not touch the bulb or the lamp glass at any time. The bulb may explode due to improper handling, including the touching of the bulb or the lamp glass.

- 1 Turn off the projector and disconnect the power cord.
- 2 Let the projector cool for at least 30 minutes.
- 3 Loosen the 2 screws that secure the lamp cover, and remove the cover.
- 4 Loosen the 2 screws that secure the lamp.

- 5 Pull up the lamp by its metal handle.
- 6 Reverse steps 1 through 5 to install the new lamp.
- 7 Reset the lamp by usage time selecting the left **Lamp Reset** icon in the OSD Management tab.

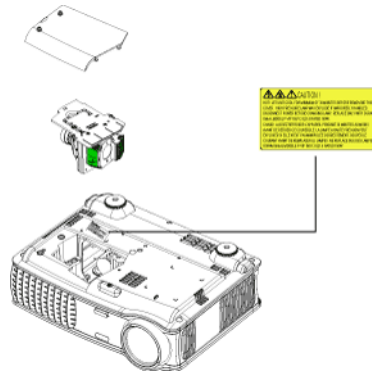
 **NOTE:** Dell may require that lamps replaced under warranty be returned to Dell. Otherwise, contact your local waste disposal agency for the address of the nearest deposit site.



 **CAUTION: Lamp Disposal (for the US only)**
 **LAMP(S) INSIDE THIS PRODUCT CONTAIN MERCURY AND MUST BE RECYCLED OR DISPOSED OF ACCORDING TO LOCAL, STATE OR FEDERAL LAWS. FOR MORE INFORMATION, GO TO WWW.DELL.COM/HG OR CONTACT THE ELECTRONIC INDUSTRIES ALLIANCE AT WWW.EIAE.ORG. FOR LAMP SPECIFIC DISPOSAL INFORMATION CHECK WWW.LAMPRECYCLE.ORG.**

Specifications

Light Valve	Single-chip 0.95" SXGA+ DLP™ LVDS (low-voltage differential signaling) technology
Brightness	3300 ANSI Lumens (Max.)
Contrast Ratio	2500:1 Typical (Full On/Full Off)
Uniformity	80% Typical (Japan Standard - JBMA)
Number of Pixels	1400 x 1050 (SXGA+)
Displayable Color	16.7M colors
Color Wheel Speed	100~127.5Hz (2X)
Projection Lens	F/2.6~2.87, f=39.1~46.92 mm with 1.2x manual zoom lens
Projection Screen Size	30.8-295.3 inches (diagonal)
Projection Distance	4.9~39.4 ft (1.5 m~12 m)
Video Compatibility	NTSC, NTSC 4.43, PAL, PAL-M, PAL-N, SECAM, and HDTV (1080i/p, 720p, 576i/p, 480i/p) compatibility Composite video, Component video and S-video capability
H. Frequency	15 kHz- 100 kHz (Analog) 30 kHz- 64 kHz (Digital)
V. Frequency	43 Hz- 120 Hz (Analog) 43 Hz- 85 Hz (Digital)
Power Supply	Universal 90-240V AC 50-60Hz with PFC input
Power Consumption	400 watts typical, 335 watts in eco mode

Audio	2 speakers, 2 watts RMS
Noise Level	37dB(A) Full-on mode, 31dB(A) Eco-mode
Weight	8.2 lbs (3.73 kgs)
Dimensions (W x H x D)	External 13 x 10.3 x 4.5 ± 0.04 inches (329.8 x 261.4 x 115.2 ± 1 mm)
Environmental	Operating temperature: 5°C - 35°C (41°F- 95°F) Humidity: 80% maximum Storage temperature: -20°C to 60°C (-4°F to 140°F) Humidity: 80% maximum
Regulatory	FCC, CE, VCCI, UL, cUL, TÜV- GS, ICES-003, C-Tick, GOST, PCBC, CCC, PSB, EZU, NOM, S-TuV/Argentina
Networking Protocol	10/100 Base-T TCP/IP ICMP ARP SNMP V1.0 SMTP DHCP HTTP
I/O Connectors	Power: AC power input socket Computer input: one M1-DA for analog/digital/component, HDTV input signals, one 15-pin D-sub for analog input/ component, HDTV input signals, one BNC R/G/B/H/V for analog RGB input signals. Computer output: one 15-pin D-sub

Video input: 3 RCA connectors for component video/ HDTV input, one mini-DIN 4-pin S-video input, one RCA jack for composite video input

Audio input: one phone jack (diameter 3.5mm)

DC jack 12 volt @ 200mA output, relay control for automatic projection screen control

One RJ45 connector for networking

One HDMI input

One mini-DIN RS232 for wired remote projector control from PC

Lamp

300-watt user-replaceable 1700-hour lamp (up to 2200 hours in eco mode)



NOTE: The actual operating life span of a projector lamp will vary according to operating conditions and usage patterns. Usage of a projector in stressful conditions which may include dusty environments, under high temperatures and abrupt powering-off may result in a lamp's shortened operating life span or possibly lamp failure. The lamp life specified for Dell's projectors refers to the typical time under non-stressful operating conditions for more than 50% of a sampling population to reduce to approximately 50% of the lamp's rated brightness level. It is not the measure of time a lamp will cease light output.

RS232 Pin Assignment

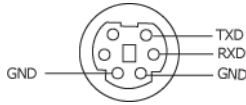

RS232 Protocol

- Communication Settings

Connection settings	Value
Baud Rate:	19200
Data Bits:	8
Parity	None
Stop Bits	1

- Command types

To pop up the OSD menu and adjust the settings.

- Control command Syntax (From PC to Projector)

[H][AC][SoP][CRC][ID][SoM][COMMAND]

- Example: Power ON Command (Send low byte firstly)

--> 0xBE, 0xEF, 0x10, 0x05, 0x00, 0xC6, 0xFF, 0x11, 0x11, 0x01, 0x00, 0x01

- Control Commands List

Go to support.dell.com to view the latest RS232 code.

PIP combination sources

Source	M1 RGB	M1 Component	VGA Computer	VGA Component	BNC RGB	BNC Component	RCA Component	HDMI
S-Video	PIP	PIP	PIP	PIP	PIP	PIP	PIP	PIP
Composite	PIP	PIP	PIP	PIP	PIP	PIP	PIP	PIP
M1 Digital	X	X	PIP	PIP	PIP	PIP	PIP	PIP



NOTE: If two sources combination overpass the bandwidth of the scaler, the projector will show the black image.

Compatibility Modes

Mode	Resolution	(ANALOG)		(DIGITAL)	
		V. Frequency (Hz)	H. Frequency (KHz)	V. Frequency (Hz)	H. Frequency (KHz)
VGA	640X350	70	31.5	70	31.5
VGA	640X350	85	37.9	85	37.9
VGA	640X400	85	37.9	85	37.9
VGA	640X480	60	31.5	60	31.5
VGA	640X480	72	37.9	72	37.9
VGA	640X480	75	37.5	75	37.5
VGA	640X480	85	43.3	85	43.3
VGA	720X400	70	31.5	70	31.5
VGA	720X400	85	37.9	85	37.9
SVGA	800X600	56	35.2	56	35.2
SVGA	800X600	60	37.9	60	37.9
SVGA	800X600	72	48.1	72	48.1
SVGA	800X600	75	46.9	75	46.9
SVGA	800X600	85	53.7	85	53.7
XGA	1024X768	43.4	35.5	-	-
XGA	1024X768	60	48.4	60	48.4
XGA	1024X768	70	56.5	70	56.5
XGA	1024X768	75	60	75	60
XGA	1024X768	85	68.7	-	-
SXGA	1280X1024	60	63.98	60	63.98
SXGA	1280X1024	75	79.98	-	-
SXGA	1280x1024	85	91.1	-	-
*SXGA+	1400x1050	60	63.98	-	-
*UXGA	1600x1200	60	75	-	-
MAC LC13*	640X480	66.66	34.98	-	-
MAC II 13*	640X480	66.68	35	-	-
MAC 16*	832X624	74.55	49.725	-	-
MAC 19*	1024X768	75	60.24	-	-
*MAC	1152X870	75.06	68.68	-	-
MAC G4	640X480	60	31.35	-	-

MAC G4	640X480	120	68.03	-	-
MAC G4	640X480	120	97.09	-	-
IMAC DV	640X480	117	60	-	-
IMAC DV	800X600	95	60	-	-
IMAC DV	1024X768	75	60	-	-
IMAC DV	1152X870	75	68.49	-	-
IMAC DV	1280X960	75	75	-	-
IMAC DV	1280X1024	85	91.1	-	-
* Compressed computer image.					



NOTE: UXGA is not supported in the DVI (M1-to-DVI).

Contacting Dell

For customers in the United States, call 800-WWW-DELL (800-999-3355).



NOTE: If you do not have an active Internet connection, you can find contact information on your purchase invoice, packing slip, bill, or Dell product catalog.

Dell provides several online and telephone-based support and service options. Availability varies by country and product, and some services may not be available in your area. To contact Dell for sales, technical support, or customer service issues:

- 1 Visit support.dell.com.
- 2 Verify your country or region in the **Choose A Country/Region** drop-down menu at the bottom of the page.
- 3 Click **Contact Us** on the left side of the page.
- 4 Select the appropriate service or support link based on your need.
- 5 Choose the method of contacting Dell that is convenient for you.

Appendix: Glossary

ANSI Lumens— A standard for measuring light output, used for comparing projectors.

Aspect Ratio—The most popular aspect ratio is 4:3 (4 by 3). Early television and computer video formats are in a 4:3 aspect ratio, which means that the width of the image is 4/3 times the height.

Backlit (Backlight)—Refers to a remote control, or a projector control panel, that has buttons and controls that are illuminated.

Bandwidth— The number of cycles per second (Hertz) expressing the difference between the lower and upper limiting frequencies of a frequency band; also, the width of a band of frequencies.

Brightness— The amount of light emitting from a display or projection display or projection device. The brightness of projector is measured by ANSI lumens.

Color Temperature— A method of measuring the whiteness of a light source. Metal halide lamps have a higher temperature compared to halogen or incandescent lights.

Component Video—A method of delivering quality video in a format that contains all the components of the original image. These components are referred to as luma and chroma and are defined as Y'Pb'Pr' for analog component and Y'Cb'Cr' for digital component. Component video is available on DVD players and projectors.

Composite Video — The combined picture signal, including vertical and horizontal blanking and synchronizing signals.

Compression— A function that deletes resolution lines from the image to fit in the display area.

Compressed SVGA— To project an 800x600 image to a VGA projector, the original 800x600 signal must be compressed down. The data displays all the information with only two thirds of the pixels (307,000 vs 480,000). The resulting image is SVGA page size but sacrifices some of the image quality. If you are using an SVGA computers, connecting VGA to a VGA projector, provide better results.

Compressed SXGA— Found on XGA projectors, compressed SXGA handling allows these projectors to handle up to 1280x1024 SXGA resolution.

Compressed XGA— Found on SVGA projectors, compressed XGA handling allows these projectors to handle 1024x768 XGA resolution.

Contrast Ratio— Range of light and dark values in a picture, or the ratio between their maximum and minimum values. There are two methods used by the projection industry to measure the ratio:

- 1 *Full On/Off* — measures the ratio of the light output of an all white image (full on) and the light output of an all black (full off) image.
- 2 *ANSI* — measures a pattern of 16 alternating black and white rectangles. The average light output from the white rectangles is divided by the average light output of the black rectangles to determine the *ANSI* contrast ratio.

Full On/Off contrast is always a larger number than *ANSI* contrast for the same projector.

dB— decibel—A unit used to express relative difference in power or intensity, usually between two acoustic or electric signals, equal to ten times the common logarithm of the ratio of the two levels.

Diagonal Screen— A method of measuring the size of a screen or a projected image. It measures from one corner to the opposite corner. A 9FT high, 12FT wide, screen has a diagonal of 15FT. This document assumes that the diagonal dimensions are for the traditional 4:3 ratio of a computer image as per the example above.

DLP— Digital Light Processing—Reflective display technology developed by Texas Instruments, using small manipulated mirrors. Light passes through a color filter is sent to the DLP mirrors which arrange the RGB colors into a picture projected onto screen, also known as DMD.

DMD— digital Micro- Mirror Device— Each DMD consists of thousands of tilting, microscopic aluminum alloy mirrors mounted on a hidden yoke.

DVI— Digital Visual Interface— Defines the digital interface between digital devices such as projectors and personal computers. For devices that support DVI, a digital to digital connection can be made that eliminates the conversion to analog and thereby delivers an unblemished image.

Focal Length— The distance from the surface of a lens to its focal point.

Frequency— It is the rate of repetition in cycles per seconds of electrical signals. Measured in Hz.

Hz — Frequency of an alternating signal. See Frequency.

Keystone Correction— Device that will correct an image of the distortion (usually a wide-top narrow-bottom effect) of a projected image caused by improper projector to screen angle.

Laser Pointer— A small pen or cigar sized pointer that contains a small battery powered laser, which can project a small, red (typically), high intensity beam of light that is immediately very visible on the screen.

Maximum Distance— The distance from a screen the projector can be to cast an image that is useable (bright enough) in a fully darkened room.

Maximum Image Size— The largest image a projector can throw in a darkened room. This is usually limited by focal range of the optics.

Metal Halide Lamp— The type of lamp used in many medium and all high end portable projectors. These lamps typically have a "half-life" of 1000-2000 hours. That is they slowly lose intensity (brightness) as they are used, and at the "half-life" point, they are half as bright as when new. These lamps output a very "hot" temperature light, similar to mercury vapor lamps used in streetlights.. Their whites are "extremely" white (with slight bluish cast.) and make Halogen lamp's whites look very yellowish by comparison.

Minimum Distance— The closest position that a projector can focus an image onto a screen.

NTSC— The United States broadcast standard for video and broadcasting.

PAL— A European and international broadcast standard for video and broadcasting. Higher resolution than NTSC.

Power Zoom— A zoom lens with the zoom in and out controlled by a motor, usually adjusted from the projector's control panel and also the remote control.

Reverse Image— Feature that allows you to flip the image horizontally. When used in a normal forward projection environment text, graphics, etc, are backwards. Reverse image is used for rear projection.

RGB— Red, Green, Blue— typically used to describe a monitor that requires separate signals for each of the three colors.

S-Video—A video transmission standard that uses a 4-pin mini-DIN connector to send video information on two signal wires called luminance (brightness, Y) and chrominance (color, C). S-Video is also referred to as Y/C.

SECAM— A French and international broadcast standard for video and broadcasting. Higher resolution than NTSC.

SVGA— Super Video Graphics Array— 800 x 600 pixels count.

SXGA— Super Ultra Graphics Array,—1280 x 1024 pixels count.

UXGA— Ultra Extended Graphics Array—1600 x 1200 pixels count.

VGA— Video Graphics Array—640 x 480 pixels count.

XGA— Extra Video Graphics Array— 1024 x 768 pixels count.

Zoom Lens— Lens with a variable focal length that allows operator to move the view in or out making the image smaller or larger.

Zoom Lens Ratio— Is the ratio between the smallest and largest image a lens can projector from a fixed distance. For example, a 1.4:1 zoom lens ratio means that a 10 foot image without zoom would be a 14 foot image with full zoom.

Index

A

- Adjusting the Projected Image 18
 - Adjusting the Projector Height 18
 - lower the projector
 - Elevator button 18
 - Elevator foot 18
 - Tilt adjustment wheel 18
 - Lowering the Projector Height 18
- Adjusting the Projector Zoom and Focus 19
 - Focus ring 19
 - Zoom tab 19

C

- Changing the Lamp 46
- Connecting the Projector
 - 12V DC power cord 14
 - Automatic screen 14
 - BNC to VGA cable 13
 - Commercial RS232 control box 16
 - Composite video cable 13
 - Connecting a Computer with a D-sub to D-sub Cable 10
 - Connecting a Computer with an M1 to D-sub/USB Cable 9
 - Connecting a DVD Player with a D-sub to YPbPr Cable 11

- Connecting a DVD Player with an M1 to HDTV Cable 11
- Connecting to a DVD Player 11
- Connection with Commercial RS232 Control Box 16
- Connection with PC 15
- D-sub to D-sub cable 10
- D-sub to YPbPr cable 11
- Installation for Driving Automatic Screen 14
- M1 to HDTV cable 11
- M1A to D-sub/USB cable 9
- Power cord 9, 10, 11, 12, 13, 14, 15, 16
- RCA to RCA component cable 12
- RS232 cable 15, 16
- To Computer 9

Connection Ports

- 12 Volt DC relay output 8
- Audio input connector 8
- Audio output connector 8
- BNC connector 8
- Component video input connector 8
- HDMI connector 8
- IR receiver/ RF transceiver 8
- Kensington lock hole 8
- M1 signal in connector 8
- Power cord connector 8
- RJ45 network connector 8
- RS232 connector 8

- S-video input connector 8
- VGA input connector 8
- VGA output connector 8
- Video input connector 8

Contacting Dell 54

Control Panel 21

D

Dell

- Contacting 54

M

Main Unit 7

- Control panel 7
- Elevator button 7
- Focus ring 7
- Lens 7
- Lens Cap 7
- Remote control transceiver 7
- Zoom tab 7

O

On-Screen Display

- Audio Menu 28
- Computer Source Menu 33
- Factory Reset Menu 33
- Image Settings Menu 26
- Language Menu 31
- Management Menu 29
- Network Settings Menu 32
- PIP Setting Menu 31

Video Source Menu 34

P

Phone numbers 54

Powering On/Off the Projector

- Powering Off the Projector 17

- Powering On the Projector 17

R

Remote Control 23

S

Specifications

- Audio 49
- Brightness 48
- Color Wheel Speed 48
- Compatibility Modes 52
- Contrast Ratio 48
- Dimensions 49
- Displayable Color 48
- Environmental 49
- H. Frequency 48
- I/O Connectors 49
- Lamp 48
- Light Valve 48
- Networking Protocol 49
- Noise Level 49
- Number of Pixels 48
- PIP combination sources 51
- Power Consumption 49
- Power Supply 48

- Projection Distance 48
- Projection Lens 48
- Projection Screen Size 48
- Regulatory 49
- RS232 Protocol 51
- Uniformity 48
- V. Frequency 48
- Video Compatibility 48
- Weight 49

Support

- Contacting Dell 54

T

- Telephone numbers 54

Troubleshooting 43

- contact Dell 43

- Self-diagnostic 46